

WATER FALL Cascade spout for wall mounting - Light Gold











IMO

13 420 979



- 120mm projection
- CASCADE, max. flow rate 26.5 l/min (at 3 bar)
- cover plate 240 x 60 mm
- 1/2" connection
- plug-link mounting

Fits: IMO, LULU, MADISON, MEM, TARA, CL.1, LISSÉ, VAIA, META, CYO

	Light Gold	13 420 979-26
	Chrome	13 420 979-00
	Brushed Platinum	13 420 979-06
	Platinum	13 420 979-08
	Dark Chrome	13 420 979-19
	Brushed Light Gold	13 420 979-27
	Brushed Durabronze (23kt Gold)	13 420 979-28
	Matte Black	13 420 979-33
	Brushed Bronze	13 420 979-42
	Brushed Champagne (22kt Gold)	13 420 979-46
	Champagne (22kt Gold)	13 420 979-47
	Brushed Chrome	13 420 979-93

Recommended miscellaneous



- Concealed wall elbow -**
- min. recess depth 90 mm
 - max. recess depth 163 mm

35 085 970 90

Recommended miscellaneous



- Concealed wall elbow -**
- min. recess depth 90 mm
 - max. recess depth 163 mm

35 085 970 90

13 420 979

mm [inches]

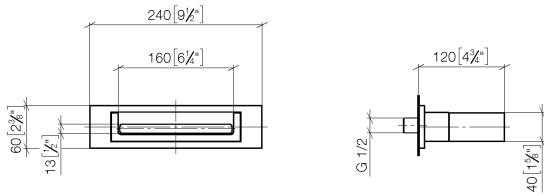

Flow rate chart



Trajectory diagram

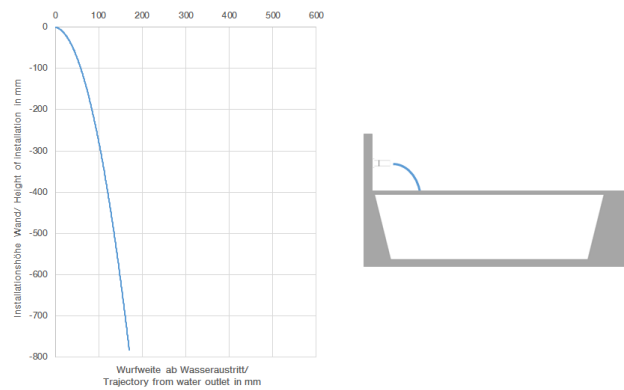

Certificates

LGA_18615.

13 420 979

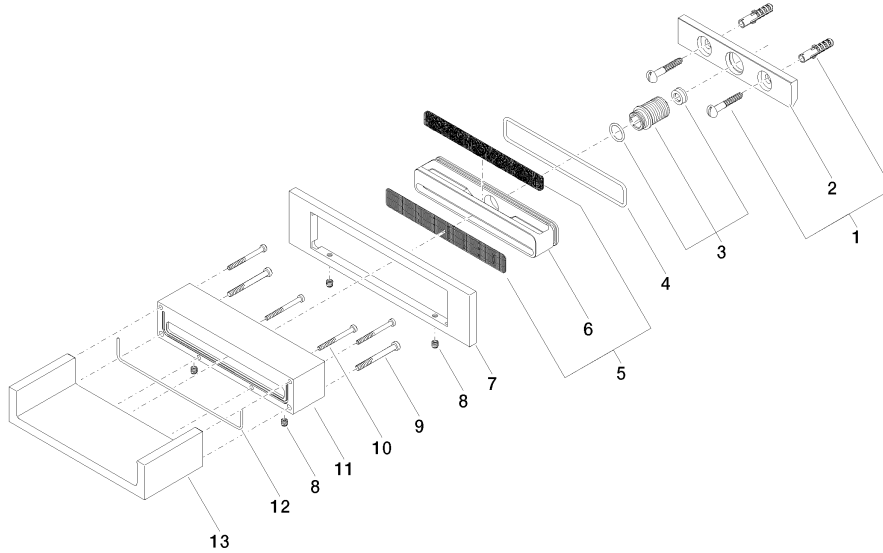

Spare parts list

No.	Item Number	Name	Quantity used	Delivery time
1	04 30 31 024 01 90	fixing set	1	2
2	09 17 97 056 90	holder	1	2
3	90 24 05 008 00 90	nipple set	1	2
4	09 14 10 504 90	seal	1	2
5	90 29 30 040 00 90	insert	1	2
6	09 17 11 044 20 90	distributor	1	2
7	09 27 97 034-26	rosette	1	60
8	09 31 11 049 90	pin	4	2
9	09 30 30 147 90	screw	2	2
10	09 30 30 086 90	screw	4	2
11	09 30 01 104-26	casing	1	60
12	09 14 03 504 90	seal	1	2
13	09 11 94 046-26	spout	1	60